

Mino Corporation

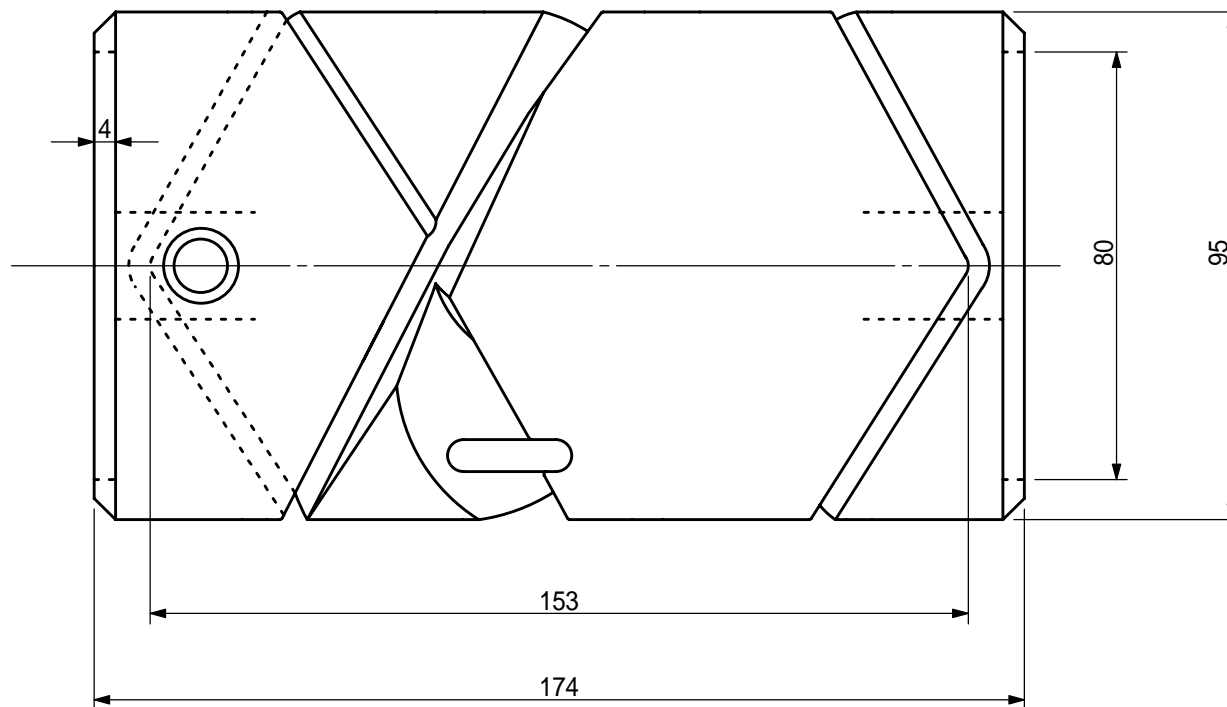

DRUM NO.	630-1.21	REF. NO	4B-91512
MATERIAL	ALUMINUM		
REMARKS	AVAILABLE WITH CERAMICS INSERT		