

Mino Corporation

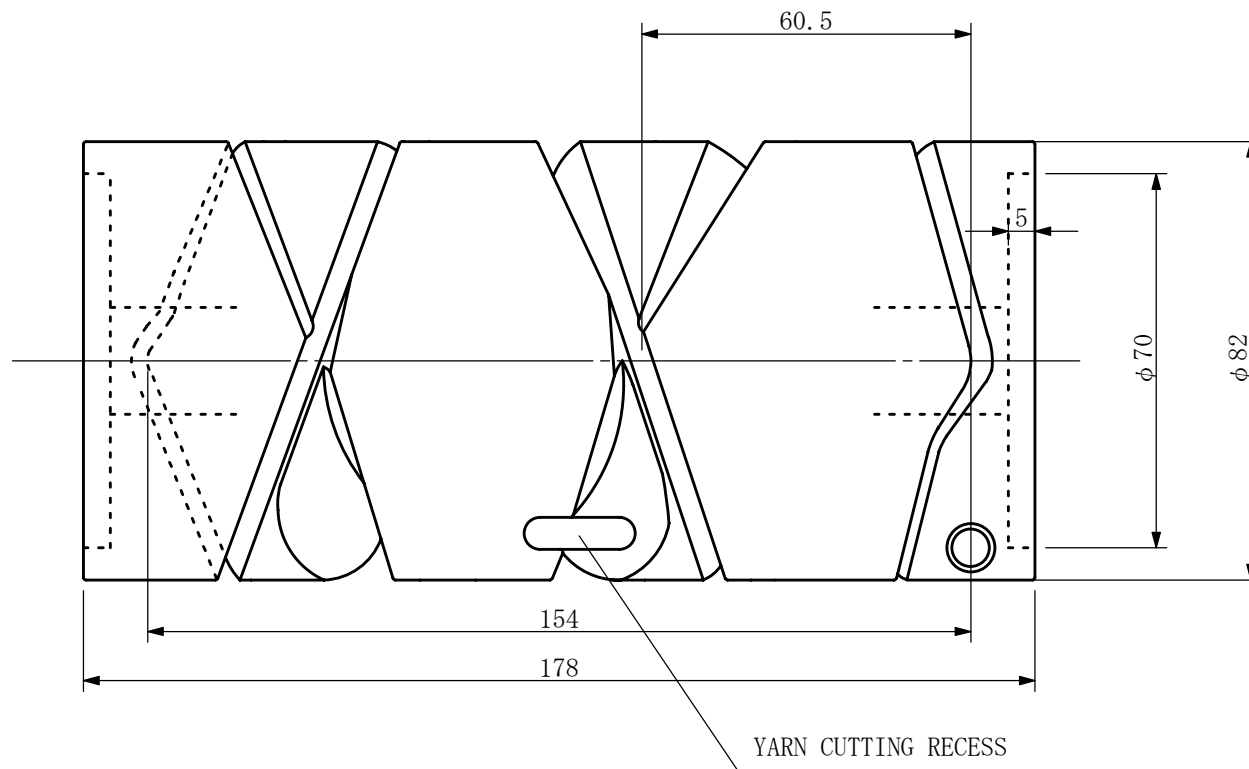

DRUM NO.	650-4.01	REF. NO	4B-85009
MATERIAL	ALUMINUM		
REMARKS	AVAILABLE WITH CERAMICS INSERT		