

Mino Corporation

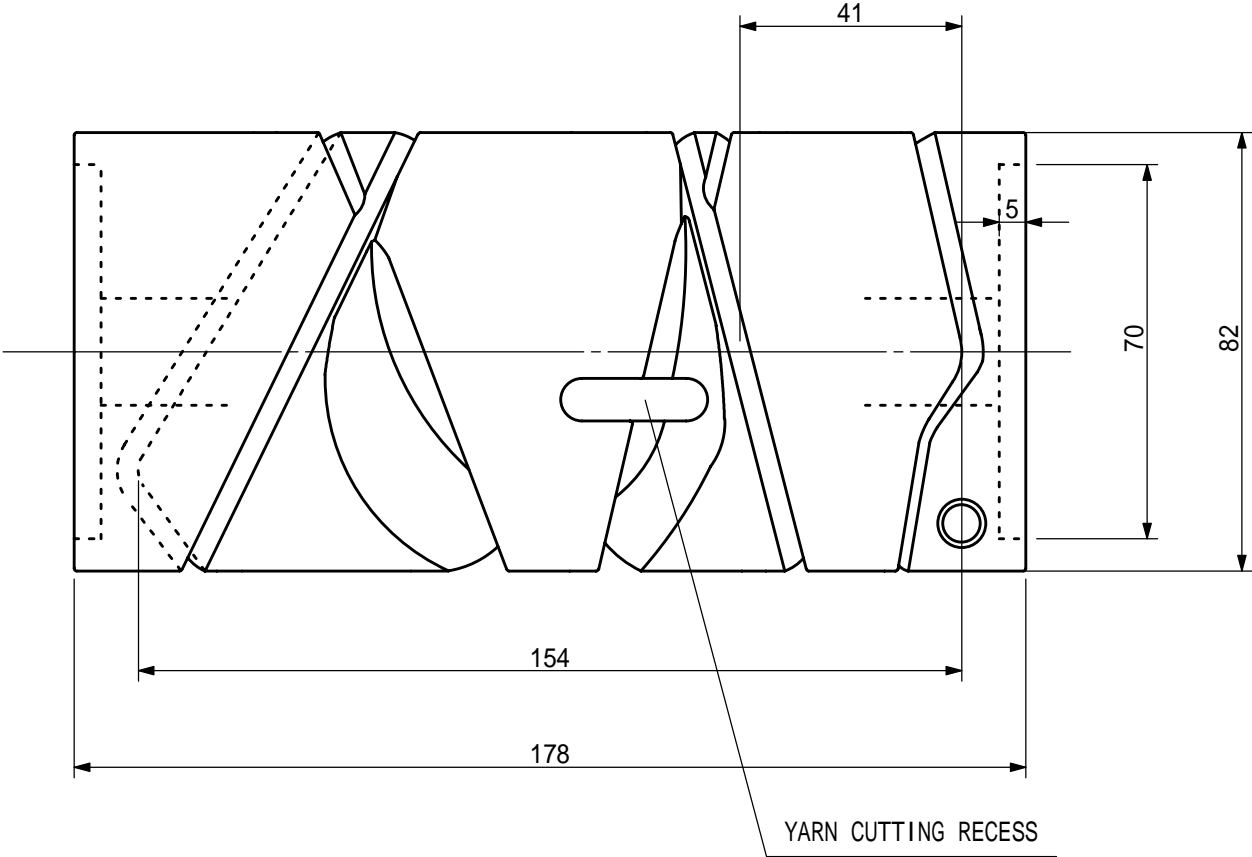

DRUM NO.	659-9.01	REF. NO	4B-84038
MATERIAL	ALUMINUM		
REMARKS	AVAILABLE WITH CERAMICS INSERT		